

Anodized Aluminum Water Manifolds

Part Number: AL-2A2-75

Quick Number: W015

Mount these Aluminum Manifolds on your molds and pre-plumb water outlets directly to the molds. The next time you run, just hook up the process hoses and you're ready to go! And, because they're aluminum, these EMI manifolds won't rust in storage.



Call 216-535-4848 or email Sales@EMIplastics.com to order.

Dimensions

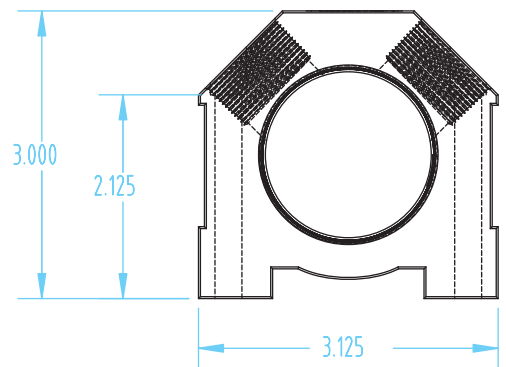
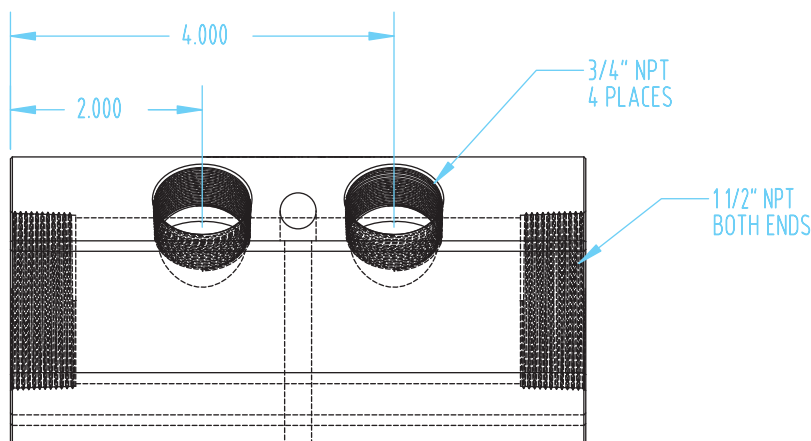
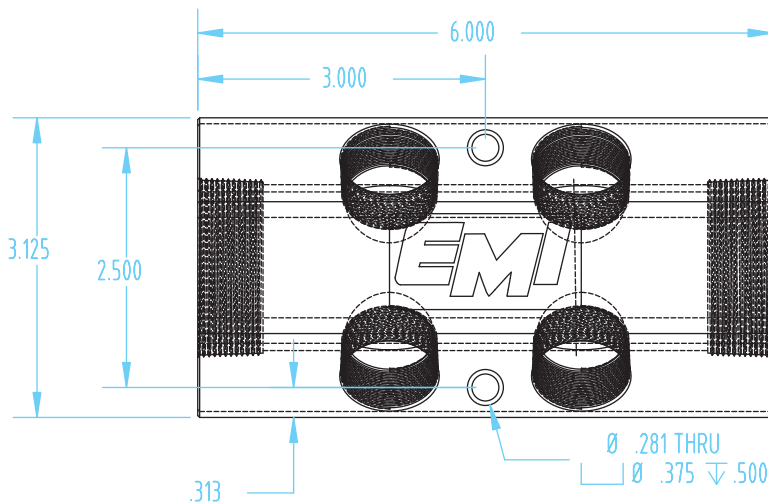

Features:

- Constructed from heavy-wall aluminum extrusions
- Standard manifolds have 1" or 1 1/2" process water ports and 3/8" or 1/2" outlets
- Pressured rated to 120 psi
- Temperature rated to 180° F
- Shipped with two complete stick-on option labels (one red and one blue) with water direction labels